

Varenummer: 2310431035
Beskrivelse: E+G Stilleben
LX.40-SW17-M8X30

Mål

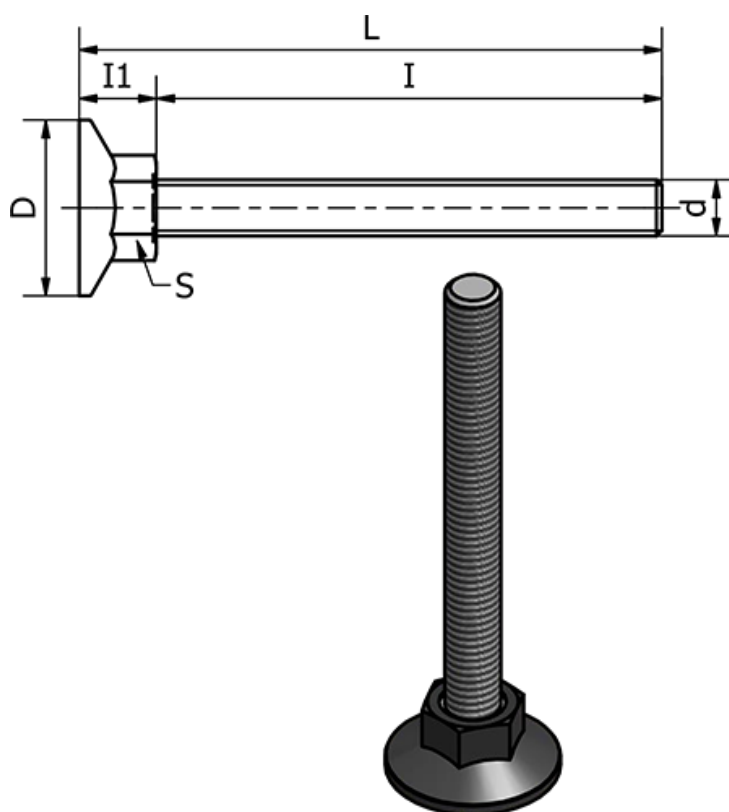

d	= M8
D	= 40
I	= 30
I1	= 13
L	= 42.5
Max statisk belastning (N)	= 2500
S	= 17
Type	= Forzinket

Vægt (g) = -